



RV4LAYS A202A

RV4 Series Industrial Potentiometer, Conductive Plastic Element, Solder lug Terminals, 2 W Power Rating, 2 kOhm Resistance Value

Representative photograph, actual product appearance may vary.

Due to regional agency approval requirements, some products may not be available in your area. Please contact your regional Honeywell office regarding your product of choice.

Features

- Robust nickel-plated brass shaft and bushings
- Conductive plastic element
- Linear taper
- 25,000 cycle rotational life
- Meets MIL-PRF-94 standards
- Locking style bushing

Typical Applications

- Manual controls (throttle, joystick)
- Electric vehicles
- Personal mobility
- Off-road vehicles
- Welding and heating
- Telecommunications

Description

The RV4 Series is a military qualified potentiometer made in accordance to MIL-PRF-94 specifications. It offers a 2 watt power rating and a conductive plastic element.

RV4LAYS A202A

RV4 Series Industrial Potentiometer, Conductive Plastic Element, Solder lug Terminals, 2 W Power Rating, 2 kOhm Resistance Value

Product Specifications	
Potentiometer Type	Industrial
Element Type	Conductive Plastic
Terminal Type	Solder lug
Power Rating	2 W
Resistance Value	2 kOhm
Resistance Tolerance	± 10 %
Linearity	± 5 %
Bushing Thread	9,53 mm [0.375 in] x 32 NEF-2A
Bushing length	12,7 mm[0.5 in]
Bushing Type	Locking
Shaft Diameter	6,35 mm [0.25 in]
Shaft length	15,88 mm [0.625 in]
Shaft Ending	Slotted
Body	27.8 mm [1.094 in] diameter max. except at terminal standoff
Electrical Taper	Linear
Operating Temperature	-55 °C to 120 °C [-67 °F to 248 °F]
Working Voltage (Max.)	500 V
Rotational Life	25000 cycles
Mechanical Rotation	312°
Availability	Global
Series Name	RV4 Series
UNSPSC Code	4111363300
UNSPSC Commodity	4111363300 Potentiometers

Honeywell

RV4LAYSA202A

RV4 Series Industrial Potentiometer, Conductive Plastic Element, Solder lug Terminals, 2 W Power Rating, 2 kOhm Resistance Value

For Reference Only mm/in

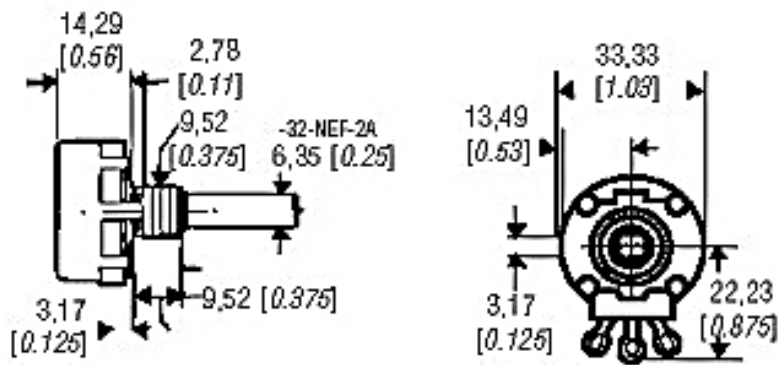

RV4N

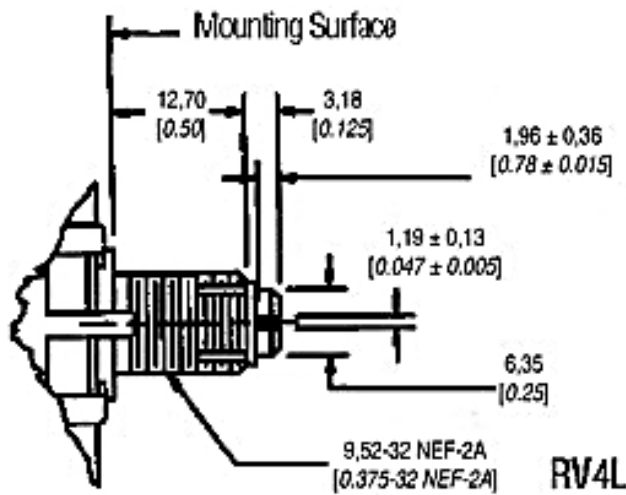

Honeywell

RV4LAYSA202A

RV4 Series Industrial Potentiometer, Conductive Plastic Element, Solder lug Terminals, 2 W Power Rating, 2 kOhm Resistance Value

 WARNING

PERSONAL INJURY

DO NOT USE these products as safety or emergency stop devices, or in any other application where failure of the product could result in personal injury.

Failure to comply with these instructions could result in death or serious injury.

 WARNING

MISUSE OF DOCUMENTATION

- The information presented in this product sheet (or catalog) is for reference only. DO NOT USE this document as product installation information.
- Complete installation, operation and maintenance information is provided in the instructions supplied with each product.

Failure to comply with these instructions could result in death or serious injury.